

CFTP/CFPPL-N

INSTALLATION INSTRUCTIONS

! IMPORTANT SAFEGUARDS !

WHEN USING ELECTRICAL EQUIPMENT, BASIC SAFETY PRECAUTIONS SHOULD ALWAYS BE FOLLOWED, INCLUDING THE FOLLOWING:

READ AND FOLLOW ALL SAFETY INSTRUCTIONS

1. To prevent high voltage from being present on red & yellow output leads prior to installation, inverter connector must be open. Do not join inverter connector until installation is complete and AC power is supplied to the emergency ballast.
2. This product is for use with one (2-pin) twin-tube or double twin-tube (quad) compact fluorescent lamp shown in the Lamp Rating Chart.
3. Make sure all connections are in accordance with the National Electrical Code and any local regulations.
4. To reduce the risk of electric shock, disconnect both normal and emergency power supplies and inverter connector of the emergency ballast before servicing.
5. This emergency ballast is for factory or field installation.
6. This product is suitable for damp locations where the ambient temperature is 0°C minimum, +50°C maximum. Product is not suitable for heated air and wet outlets or hazardous locations.
7. An unswitched AC power source is required (120 or 277 VAC, 60 Hz).
8. Do not install near gas or electric heaters.
9. Do not attempt to service the battery. A sealed, no-maintenance battery is used that is not field replaceable. Contact the manufacturer for information on service.
10. The use of accessory equipment not recommended by the manufacturer may cause an unsafe condition.
11. Do not use this product for other than intended use.
12. Servicing should be performed by qualified service personnel.

Lamp Rating Chart

LAMP (One 2-pin Lamp)	BASE	WATTAGE
Twin Tube	G23	5, 7, 9
	GX23	13
Quad Tube	G23	9
	G24d	10
	GX23	13

SAVE THESE INSTRUCTIONS



CONTAINS NICKEL-CADMIUM
RECHARGEABLE BATTERY.
MUST BE RECYCLED OR
DISPOSED OF PROPERLY.



06/10/10

272 West Stag Park Service Road • Burgaw, NC 28425 • (910) 259-1000 • FAX (800) 258-8803
70041307

INSTALLATION



WARNING: TO PREVENT HIGH VOLTAGE ON RED & YELLOW OUTPUT LEADS PRIOR TO INSTALLATION, INVERTER CONNECTOR MUST BE OPEN. DO NOT JOIN INVERTER CONNECTOR UNTIL INSTALLATION IS COMPLETE AND AC POWER IS SUPPLIED TO THE EMERGENCY BALLAST.

NOTE: Make sure that the necessary branch circuit wiring is available. An unswitched source of power is required. The emergency ballast must be fed from the same branch circuit as the AC ballast.

1. Disconnect AC power from the fixture.
2. Select the appropriate wiring diagram to connect the emergency ballast to the AC ballast and lamp.
3. Refer to Diagram A to install the emergency ballast and test/monitor plate. Make electrical connections in accordance with the National Electrical Code and any local regulations. The test/monitor plate may be installed close to the fixture in the ceiling or at a remote location (up to 50 feet). The emergency ballast may be remotely installed up to 1/2 the distance the AC ballast manufacturer recommends removing the AC ballast from the lamp, or up to 50 feet, whichever is less. If no AC ballast is used, the emergency ballast can be remotely mounted up to 50 feet away.

DIAGRAM A

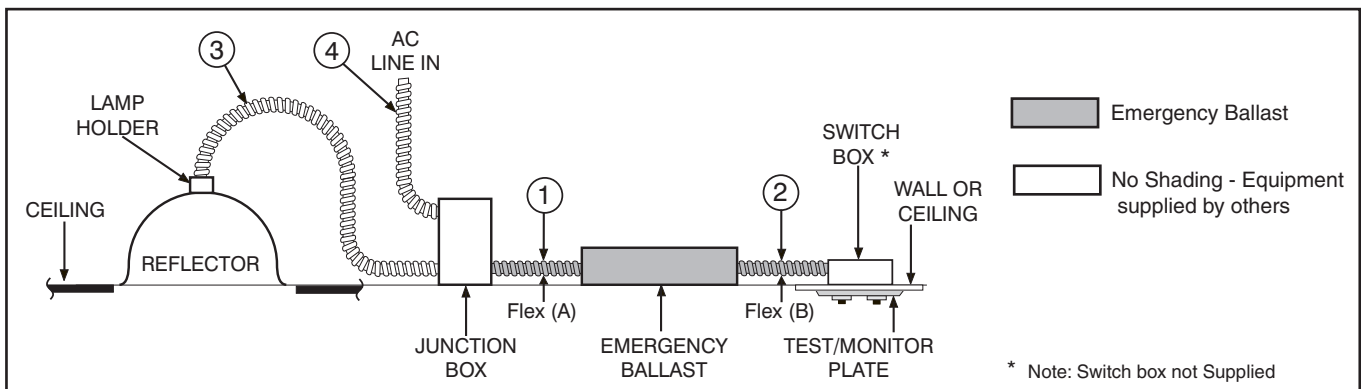

- ① Flexible conduit (B) to test/monitor plate (see Diagrams B and C).
- ② Flexible conduit (A) to connect ballast wires (see Diagrams B and C).
- ③ Existing conduit to run existing wires to lamp holder (AC ballast on junction box). If AC ballast is on reflector, run yellow and blue wires from emergency ballast through this conduit.
- ④ AC line in.

DIAGRAM B

DIAGRAM C

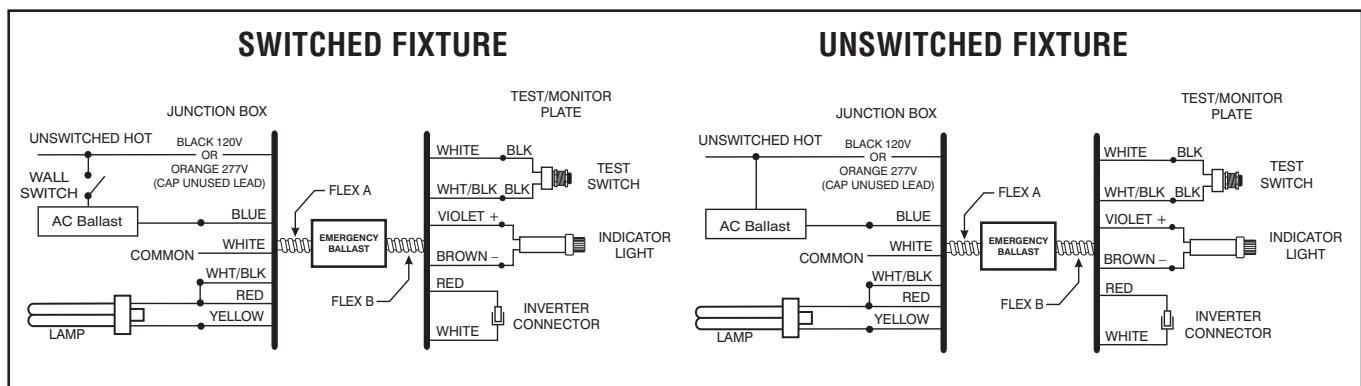

For 120 VAC, connect unswitched hot to black emergency ballast lead and cap unused orange wire.

For 277 VAC, connect unswitched hot to orange emergency ballast lead and cap unused black wire.

4. The emergency ballast can be used with one- or two- lamp fixtures, and operates one lamp in the emergency mode. See back page for more detailed wiring schematics.
5. Cut fixture wire between the lamp holder and AC ballasts and connect the blue emergency ballast wire to the AC ballast and the yellow wire to the lamp holder.
6. On switched fixtures, an additional unswitched hot (120 or 277 VAC) wire must be run to the junction box and connected to the emergency ballast.
7. The emergency ballast must be connected to an unswitched 120 or 277 VAC power source. Do not connect to other voltages. After fixture installation is complete, supply AC power to the emergency ballast, then join the inverter connector.
8. For short-term testing of the emergency function, the battery must be charged for at least one hour. The emergency ballast must be charged for at least 24 hours before conducting a long-term test.
9. In a readily visible location, attach the label "CAUTION: This Unit Has More Than One Power Supply Connection Point. To Reduce The Risk Of Electric Shock, Disconnect Both The Branch Circuit-Breakers Or Fuses And Emergency Power Supplies Before Servicing."

OPERATION

When AC power is applied, the charging indicator light is illuminated, indicating that the battery is being charged. When power fails, the emergency ballast automatically switches to emergency power, providing at least 90 minutes of emergency lighting.

MAINTENANCE

Although no routine maintenance is required to keep the emergency ballast functional, it should be checked periodically to ensure that it is working. The following schedule is recommended:

1. Visually inspect the charging indicator light monthly. It should be illuminated.
2. Test operation of the circuit at 30-day intervals for a minimum of 30 seconds. One lamp should operate at reduced illumination.
3. Conduct a 90-minute discharge test once a year. One lamp should operate at reduced illumination for at least 90 minutes.

REFER ANY SERVICING INDICATED BY THESE CHECKS TO QUALIFIED PERSONNEL.

EMERGENCY BALLAST AND AC BALLAST MUST BE FED FROM THE SAME BRANCH CIRCUIT
 TYPICAL SCHEMATICS ONLY. MAY BE USED WITH OTHER BALLASTS. CONSULT THE FACTORY FOR OTHER WIRING DIAGRAMS.

WIRING DIAGRAMS FOR 1-LAMP EMERGENCY OPERATION

FIG C238 TWO-LAMP FIXTURE, TWO SIMPLE REACTOR AC BALLASTS

FIG C239 TWO-LAMP FIXTURE, TWO AUTOTRANSFORMER AC BALLASTS

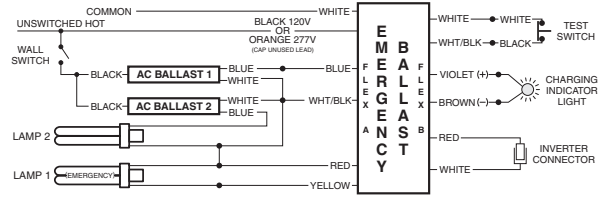
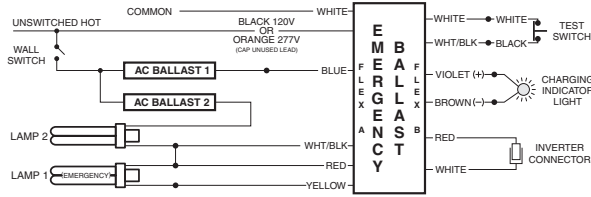

FIG C240 ONE-LAMP FIXTURE, ONE SIMPLE REACTOR AC BALLAST

FIG C241 ONE-LAMP FIXTURE, ONE AUTOTRANSFORMER AC BALLAST

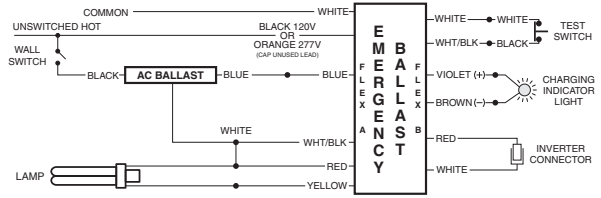
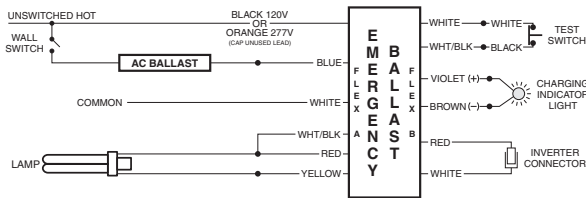
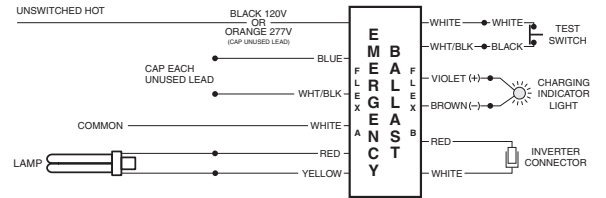
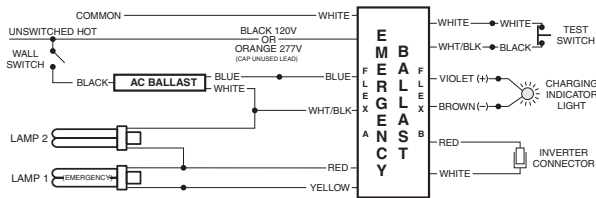

FIG C203 TWO-LAMP FIXTURE, ONE MAGNETIC AC BALLAST

FIG C242 ONE-LAMP FIXTURE WITHOUT AC BALLAST



**This emergency ballast is also compatible with other AC ballasts.
 Please contact factory with AC ballast model number for wiring diagrams.**